



Solar HVAC 230V | Model "Z" 5-Ton Condensing Unit

Part Number

SHRDZ- 600*00A000 - **

Unit Type

D - Cooling Only

Voltage (*)

G - 230 VAC 1Φ
H - 230 VAC 3Φ

Options (**)

0 - No Options
D - Condenser Coil Coating (UG)
Y - Start Up
7 - Phase Monitor

Description

A Solar HVAC Residential Unit is more than twice as efficient as a standard residential split unit.

A solar box equipped with chambers lined with specialty reflective film is mounted to the top of the condensing unit. Through a patented process, ambient light is converted to thermal energy which reduces the energy demand on the compressor.

Units come with a 1-year parts warranty and 10 year compressor warranty.

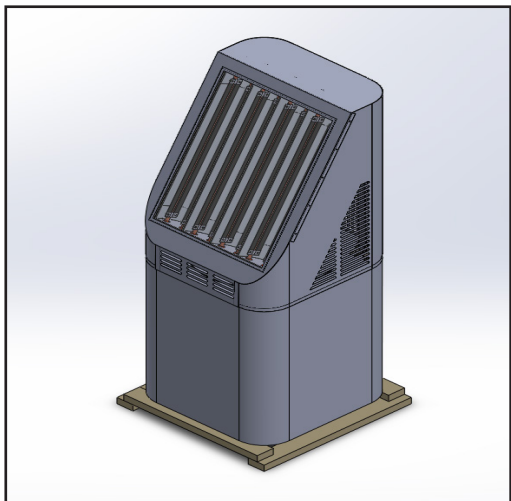



Dimensions

SHRDZ-60 | Solar HVAC Model "Z" Residential Condenser Dimensions

Model		SHRDZ-60 (5 Ton)	
Code	Outdoor Code		
Outdoor Power Supply	V/Hz	208-230V/60Hz	
Cooling	Capacity	Btu/h	56000
		W	5185
	EER	Btu/h, W	10.8
	SEER		17.5
Compressor	Type	Twin-rotary DC	
Outdoor Dimension	Packing (WxHxD)	Inch	32-5/8 x 32-5/8 x 79-5/8

(Outdoor Unit) Model		SHRDZ-60 (5 Ton)	
Outdoor Weight	Net - Lbs (kg)	301 (137)	
	*Gross - Lbs (kg)	306 (139)	
Electrical Data 208/230 1φ	Minimum Circuit Ampacity	36.5 A	
	Max. Overcurrent Protection	60 A	
Electrical Data 208/230 3φ	Minimum Circuit Ampacity	21.09 A	
	Max. Overcurrent Protection	30 A	
Outdoor Noise Level (dB(A))		79	
Operation Temperatures (°F)		5 - 118	

Note:

Unit should be UL 1995 listed

Unit should be OG-100 Certified to the Solar certification on ICC901/SRCC100

Note:

Face solar panels south for optimal performance.

* Gross = Net Weight + Shipping Box

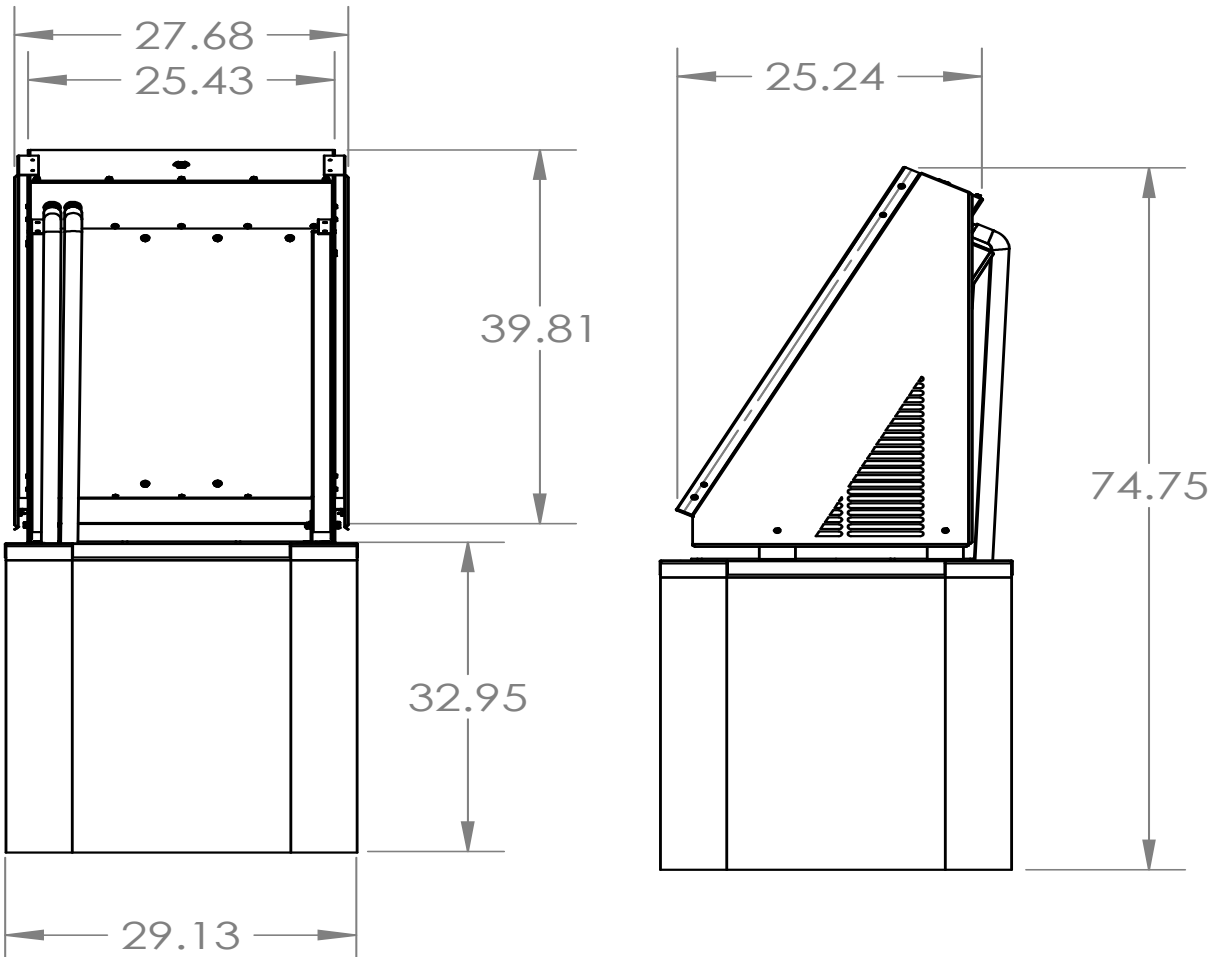

SHRDZ-60 | Solar HVAC Model "Z" Residential Condenser Clearances

SHR*-** Clearances | v 2.00 | 05/20/22

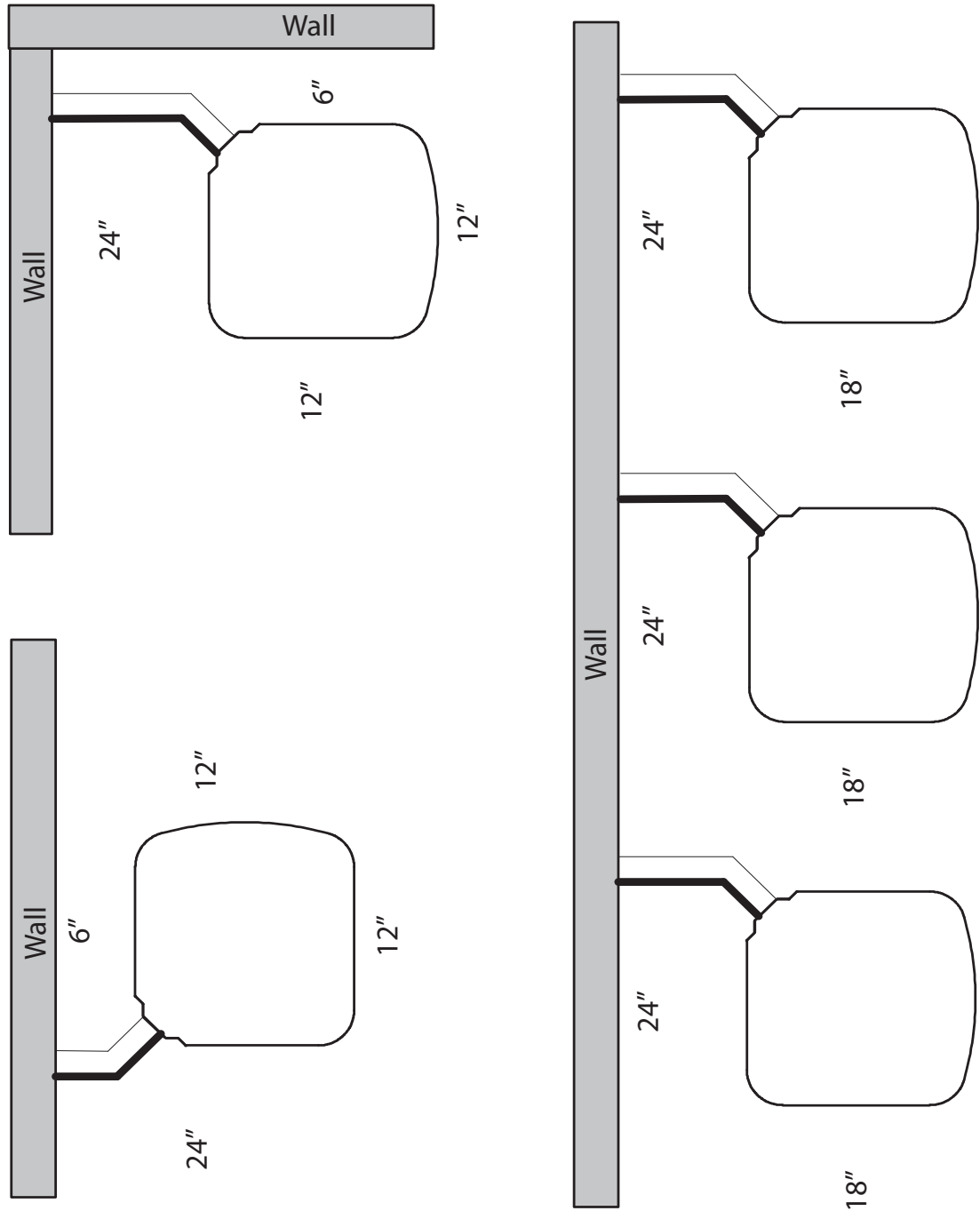

* - Unit Type (Cooling Only (D) or Heat Pump (P))

** - BTU's - x 1000 (24, 36, 48, 60)