



Solar HVAC 230V | Model "Z" 5-Ton Condensing Unit

Part Number

SHRPZ- 600*00A000 - **

Unit Type

P - Heat Pump

Voltage (*)

G - 230 VAC 1Φ
H - 230 VAC 3Φ

Options (**)

0 - No Options
D - Condenser Coil Coating (UG)
Y - Start Up
7 - Phase Monitor

Description

A Solar HVAC Residential Unit is more than twice as efficient as a standard residential split unit.

A solar box equipped with chambers lined with specialty reflective film is mounted to the top of the condensing unit. Through a patented process, ambient light is converted to thermal energy which reduces the energy demand on the compressor.

ultraRES takes the highest efficiency condensing unit (made with the patented solar HVAC system) and pairs it with an air handling unit that comes equipped with a 4" filter box with a MERV 13 filter and VOC sensor. The 4" MERV 13 filter provides more than 4 times the filter efficiency of a standard 1" pleated filter. The VOC sensor is mounted in the space and provides the owner with feedback on how clean or dirty the air is inside the space.

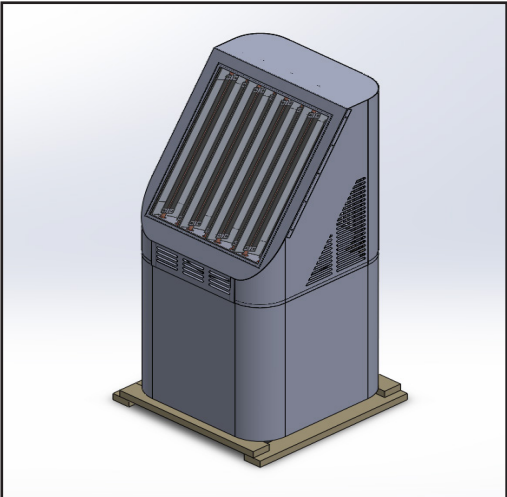

Units come with a 1-year parts warranty and 10 year compressor warranty.



Dimensions

SHRPZ-60 | Solar HVAC Model "Z" Residential Condenser Dimensions

Model		SHRPZ-60 (5 Ton)	
Code	Outdoor Code		
Outdoor Power Supply	V/Hz	208-230V/60Hz	
Cooling	Capacity	Btu/h	56000
		W	5185
	EER	Btu/h, W	10.8
	SEER		17.5
Heating	Capacity	Btu/h	55000
	COP	Btu/h.W	3.16
	HSPF		9.5
Compressor	Type	Twin-rotary DC	
Outdoor Dimension	Packing (WxHxD)	Inch	32-3/8 x 32-3/8 x 76

(Outdoor Unit) Model		SHRPZ-60 (5 Ton)	
Outdoor Weight	Net - Lbs (kg)	301 (137)	
	*Gross - Lbs (kg)	306 (139)	
Electrical Data 208/230 1φ	Minimum Circuit Ampacity	36.5 A	
	Max. Overcurrent Protection	60 A	
Electrical Data 208/230 3φ	Minimum Circuit Ampacity	21.09 A	
	Max. Overcurrent Protection	30 A	
Outdoor Noise Level (dB(A))		79	
Operation Temperatures (°F)		5 - 118	

* Gross = Net Weight + Shipping Box

Note: Calculated E COP value with solar panel: 3.89

Note:

Unit should be UL 1995 listed

Unit should be OG-100 Certified to the Solar certification on ICC901/SRCC100

Note:

Face solar panels south for optimal performance.

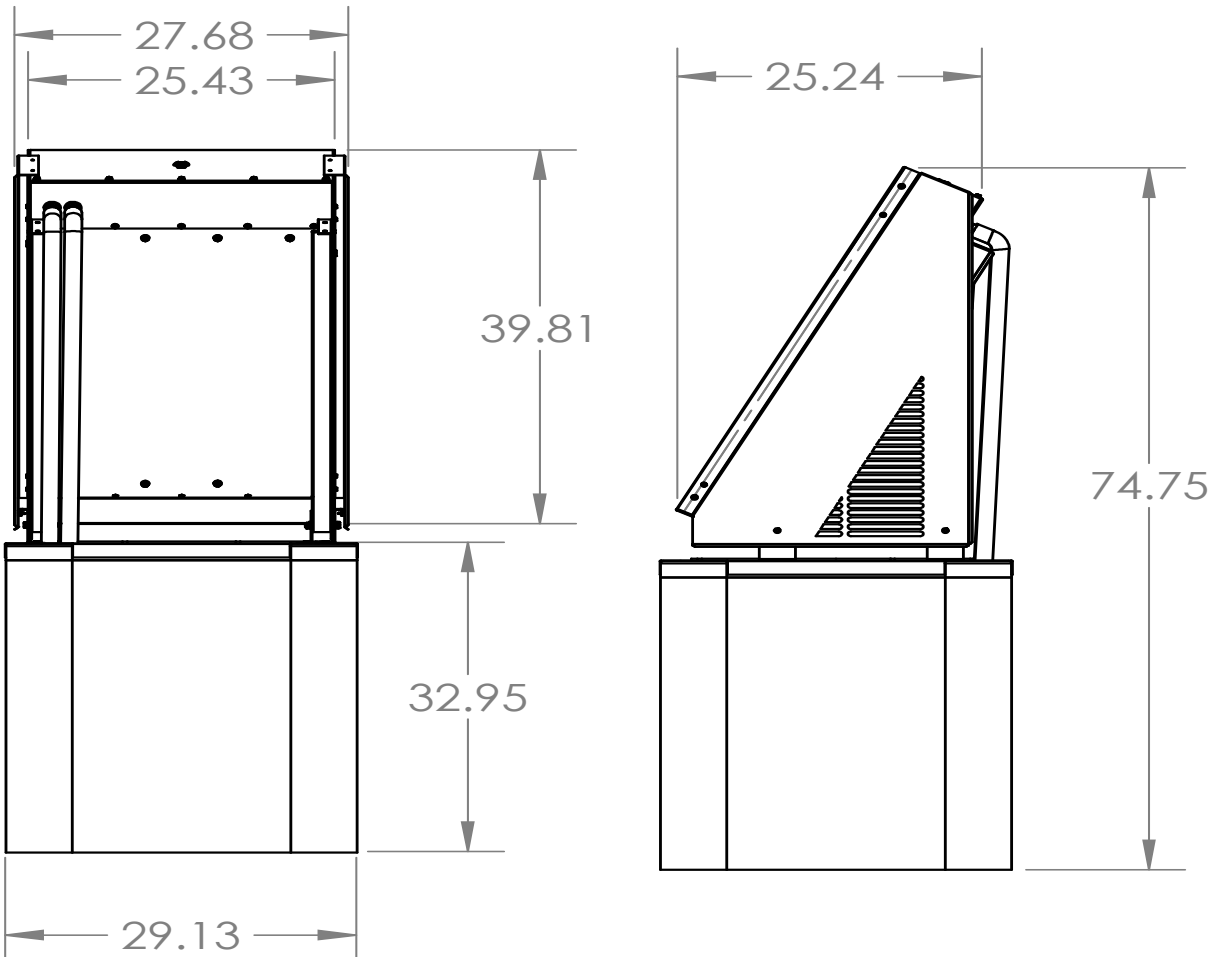

SHRPZ-60 | Solar HVAC Model "Z" Residential Condenser Clearances

SHR*-** Clearances | v 2.00 | 05/20/22

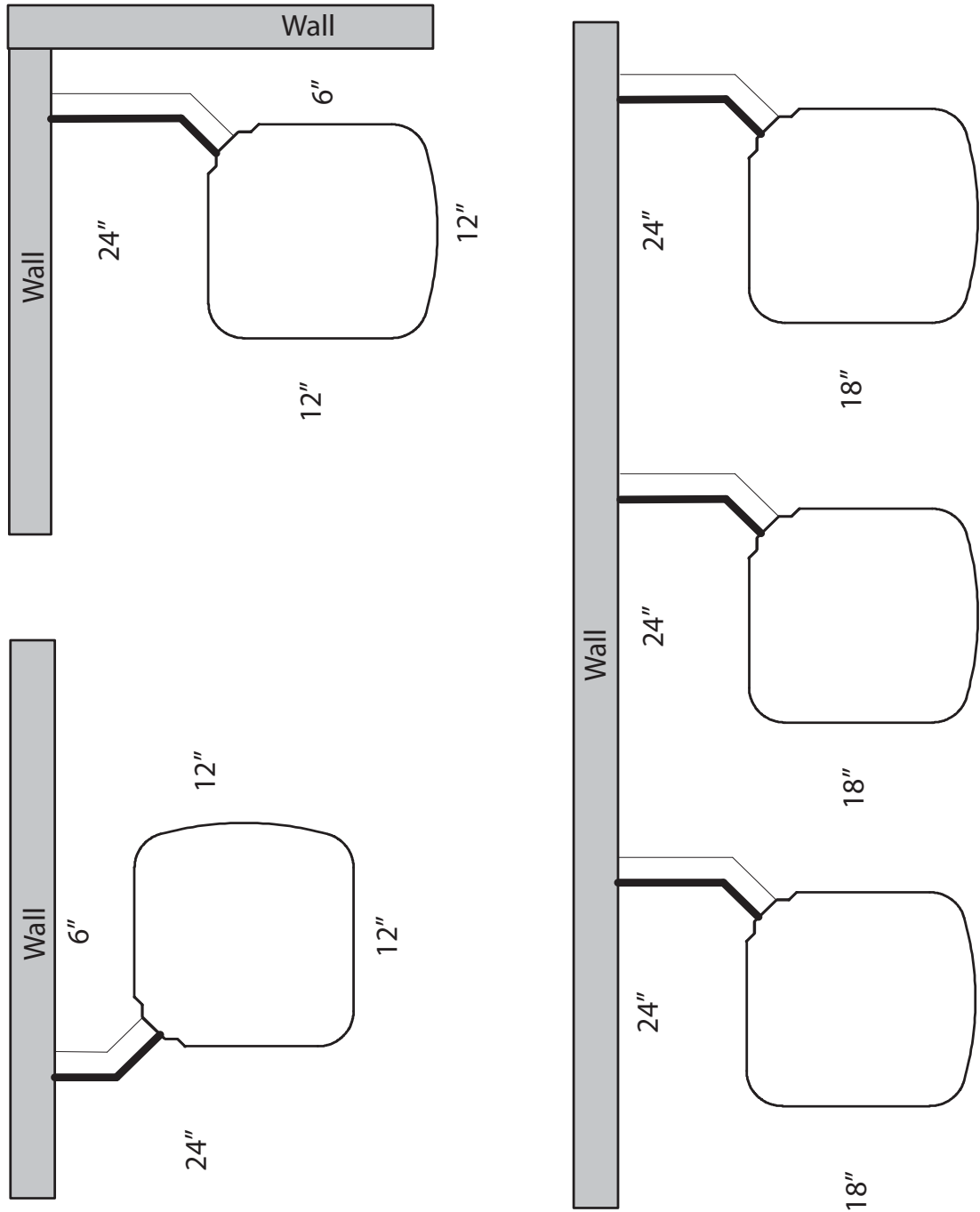

* - Unit Type (Cooling Only (D) or Heat Pump (P))

** - BTU's - x 1000 (24, 36, 48, 60)