



Product Data

EC-PACK-***0-* | Trane Economizer

Description

PLEASE NOTE: Our economizer is a low leak, field installed economizer with the iAIRE patented controls packages and actuator, allowing you to reduce the amount of outside air needed from your rooftop HVAC system by up to 2/3 and will improve indoor air quality.

This reduction in system operation creates on-going utility savings. Payback on capital equipment costs with an iAIRE economizer can be realized in fewer than three years. These packages are designed to work directly on existing rooftop HVAC systems.

These economizers are all low leak and meet the IECC 2015 requirement and are Title 24 compliant by meeting section 120.2(i) for the required controls and the efficiency requirements in 140.4(e).

Unit to RTU Conversion	
PACK13-V	4 TCY/WCY/YCY 5024-036, 4 DCZ/WCZ/YCZ 6036, 4 TCC/YCC/WCC 4018-036, 4 DCY 4024-036
PACK15-H	4 TCY/WCY/YCY 5024-060, 4 DCZ/WCZ/YCZ 6036-6060, 4 TCC/YCC/WCC 4018-060, 4 DCY 4024-060
PACK35-V	4 TCY/WCY/YCY 5042-060, 4 DCZ/WCZ/YCZ 6048 & 6060, 4 TCC/YCC/WCC 4042-060, 4 DCY 4042-060

Part Number

EC - 1 - 2 3 4 5 - 6

type	unit/ton (1)							
EC - ECONOMIZER	26	6075	CHAS12	A-BOX	FND35	PREC810	AFF	SCL34
	712	100	CHAS34	B-BOX	PACK13	VOY12	LXS	SCLHE12
	1525	125	CHAS5	C-BOX	PREC35	VOY12HE	LXL	SCLHE34
	3050	150	CHAS69	D-BOX	PREC48	VOY1525HE	SCS12	PRED
			E-BOX	PREC610		SCS34	PREDS	
			F-BOX			SCSHE12	SL	
						SCSHE34	SLL	
						SCL12	SLU	

Controls Only
Carrier
Lennox
Trane
York

configuration (2)

- 0 - NO ECON
- C - CONVERTIBLE
- H - HORIZONTAL
- V - VERTICAL

actuator (3)

- 0 - NO ACTUATOR
- A - 20 IN-LB
- B - 62 IN-LB
- C - 160 IN-LB

controls (4)

- 0 - ECON ONLY
- A - IAQ
- B - IAQ (NO IONIZATION)
- D - DCV

power exhaust (5)

- 0 - NO POWER EXHAUST
- A - 208/230V 1Φ FIXED PE
- B - 208/230V 3Φ FIXED PE
- C - 460V 3Φ FIXED PE

options (6)

- 0 - NONE
- B - HUMIDITY
- C - BACNET
- D - BLDG PRESSURE*
- R - RTU OPEN
- U - ULTRA LOW LEAK

Note: By adding option "D" any powered exhaust will be modulating.

EC - PACK35 - VBA0 - * | Trane Economizer

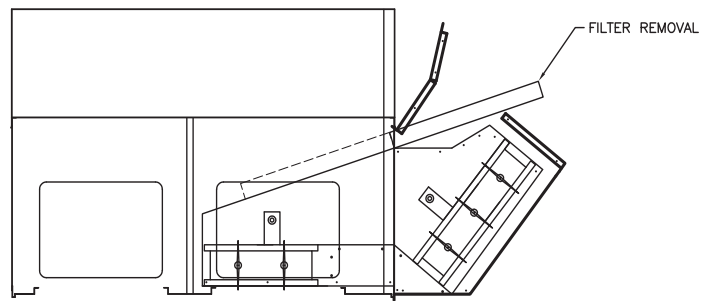
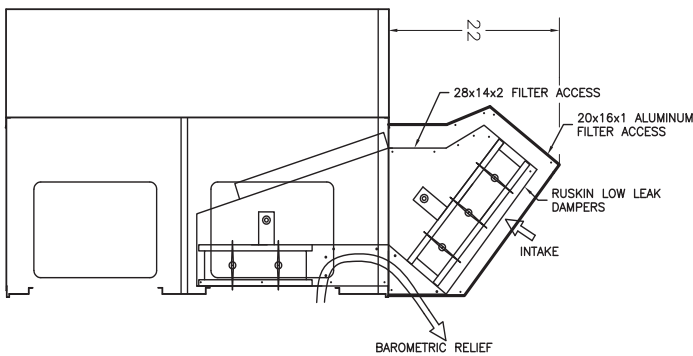
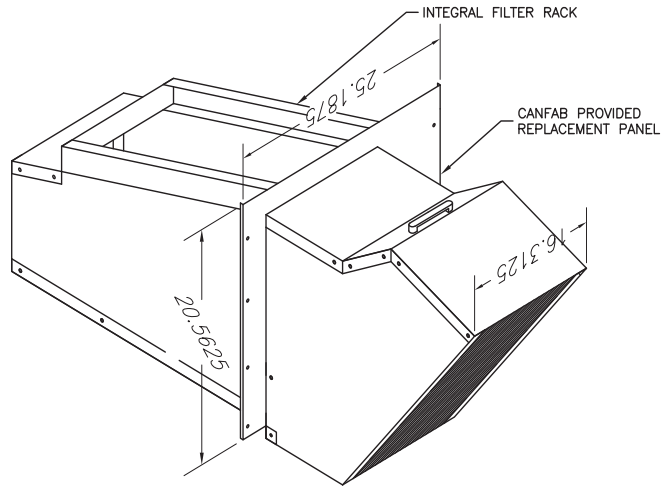

Electrical Data

PART #	WEIGHT
EC-PACK35-VBA0-*	95 lbs.

PART	AMPS	PART	AMPS	TOTAL
ACTUATOR	.29A	CONTROLS	.27A	.56A

*OPTIONS
0 - No Options
B - Humidity/Enthalpic
C - BACNet

Features

- **IAIRE Patented Controls Scheme Included**
- Low Leak Damper Included
- VOC, CO2 and Ionization included
- Heavy Gauge Galvanized Steel Construction
- American Sterling Grey Paint Finish
- One Piece Assembly
- Gear Driven Dampers
- Uses HVAC Unit Filter Access Door
- Capable of Relieving up to 100% of the Outside Air Intake

Economizers with Indoor Air Quality control are Title 24 compliant by meeting section 120.2(i) for the required controls and the efficiency requirements in 140.4(e). They also meet California ozone emissions requirements to be CARB certified.